

SE600™ 3D SPI

Ultimate Precision Accuracy with World-class Usability

SYSTEM SPECIFICATIONS	
Panel Size Capacity (Max)	510 x 510 mm (20.0 x 20.0 in.)
Panel Size Capacity (Min)	50 x 50 mm (2.0 x 2.0 in.)
System Dimensions (W x D X H)	110 x 127 x 139 cm
Weight	≈965 kg (2127 lbs.)
Maximum panel weight	3.0 kg (6.6 lbs)
Board Thickness	0.3 mm to 5.0 mm (0.01 in. to 0.2 in.)
Board edge clearance (Top)	Top: 2.5 mm (0.10 in.); Bottom: 3.0 mm (0.12 in.)
Component Clearance (Top)	Top (above belt): 20.1 mm (0.78 in.); Bottom: 25.4 mm (1.0 in.)
Conveyor Speed Range	150–450 mm/sec (5.9–17.7 in./sec)
Conveyor Adjustment	Automatic
FUNCTIONAL SPECIFICATIONS	
Maximum Inspection Area	508 x 503 mm (20.0 x 19.5 in.)
Field-of-View (FOV)	32 x 32 mm (1.26 x 1.26 in.)
X and Y Pixel Size @	High Resolution: 15 μm (0.6 mils); High Speed: 30 μm (1.2 mils)
Paste Height Range	50–500 μm (2–20 mils)
Height Resolution	0.2 μm (0.008 mils)
Maximum Board Warp	< 2% of PCB diagonals or max. of 6.35mm (0.25 in) total
Maximum Pad Size in FOV	15 x 15 mm (0.6 x 0.6 in.)
Measurement Types	Height, Area, Volume, Registration, Bridge Detection, Defect Review
Machine Interface	SMEMA, RS232 & Ethernet
Power Requirements	100–130 / 220–240V (10%), 50/60 Hz, 10–15 amps
Compressed Air Requirements	5.6 to 7.0 Kgf/cm ² (80 to 100 psi @ 4 cfm)
PERFORMANCE SPECIFICATIONS	
Inspection Speed @ 30um	108 cm ² /sec peak (80 cm ² /sec avg)
Inspection Speed @ 15um	56 cm ² /sec peak (30 cm ² /sec avg)
Fiducial, Barcode and Skip Mark	All-in-one scan
Height Accuracy†	2 μm on a Certification Target
Gage R&R†	<<5%, 6σ on Printed Circuit Board; <<2%, 6σ on Certification Target
† Under controlled conditions	

OPTIONS
SPC software, Barcode Readers (1D/2D), Programming Software: ePM-SPI/AOI & GC-PowerPlace, Offline Defect Review, Certification Target



SE600



- EM Asia Innovation Award for SPI V5 software
- EM Asia Innovation Award for SE600
- SMTA Best Exhibit Technology Award for SE600
- SMTA Best Emerging Exhibit Award for SE600



*On standard parts only (excludes conveyor belts and other consumables); 1 year warranty on service

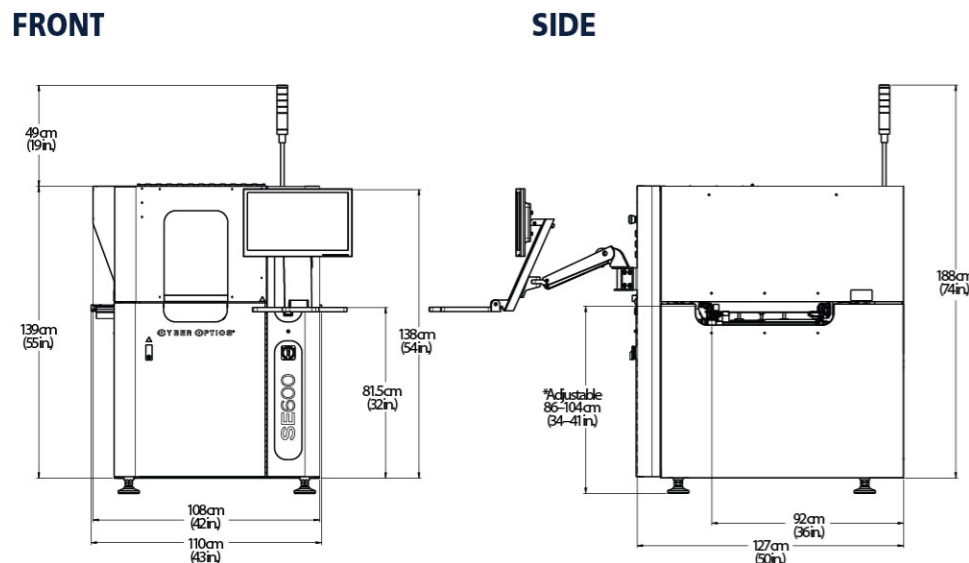

Americas
CyberOptics Corporation
Minneapolis, Minnesota
USA
Tel: + 1 763 542 5000

Asia Pacific
CyberOptics Singapore
Singapore
Tel: + 65 6744 3021

China
CyberOptics China Company, Ltd.
Kunshan
Tel: + 86 512 50156306

Europe
CyberOptics Ltd.
United Kingdom
Tel: + 44 1423 871 411

info@cyberoptics.com

www.cyberoptics.com

SE600™ 3D SPI
Ultimate Precision Accuracy with World-class Usability
World's Fastest and Most Accurate 3D SPI

TRUE MEASUREMENT, SUPREME QUALITY

- All-new, Standard Dual Illumination Sensor with calibration-free design
- Award-winning Newly Designed Software
- Multi-touch Screen with Intuitive Operation
- Best-in-class Accuracy and Repeatability
- Closed Loop Feedback Ready
- CyberPrint OPTIMIZER™ Ready
- Mounter Feed Forward Ready

Specifications subject to change without notice.
Copyright © 2014 CyberOptics Corporation, Inc.
All Rights Reserved. 8021100, Rev C 5/14

PERFORMANCE AT ITS BEST (ACCURACY AND GR&R)

SE600™ comes with a standard dual illumination sensor designed and built exclusively by CyberOptics. The sensor offers the best repeatability and reproducibility results - even on the smallest paste deposits. The sensor is manufactured as an integrated assembly with absolutely no moving parts – which means no machine-to-machine variation. So, you can be assured that there is no drift over time, no parts to wear and most importantly - no recalibration required.

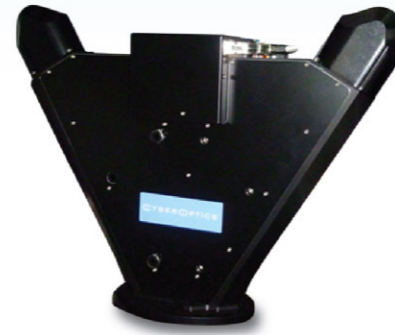

Dual Illumination Sensor



Scan here to understand why 'True Height Measurement' accuracy is critical for SPI.

NEW, AWARD-WINNING INTUITIVE SOFTWARE

The brand-new V5 series software delivers world-class user experience with its intuitive interface, completely changing the way users interact with our system. Yet, at the same time, the software is extremely stable and simple to use enabling shortest learning curve.

With full multi-touch experience, SPI V5 series software offers a range of revolutionary features that enable smarter and faster inspection:

- Seamless integration of all applications - Teach, Inspection, Defect Review and Real-time SPC
- Unlimited undo-redo and global search options in Teach
- Loads of smart, informative and relevant charts that provide yield summary, FPY information, hotspot display, top 10 pad failures, historical panel and more.
- Easy, hassle-free operation using multi-touch, multi-selection, pinch-zoom and pan-move options

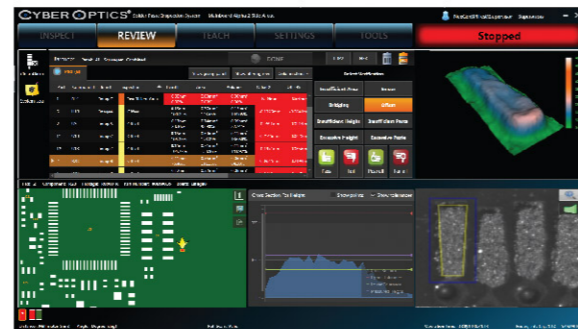

Defect Review Interface

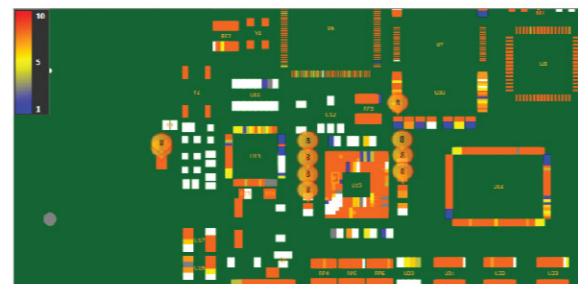

Hotspot Display

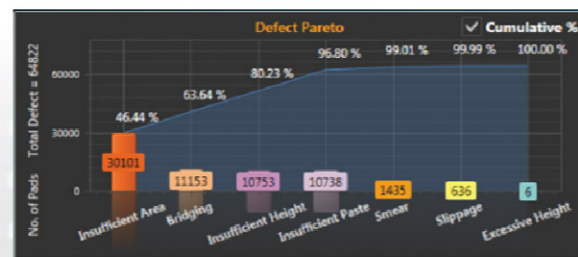

Real-time SPC

SE600™ 3D SPI

Ultimate Precision Accuracy with World-class Usability

HIGH SPEED, ON-THE-FLY INSPECTION

SE600™ incorporates CyberOptics' patented 3-D sensing technology that uses white strobe light acquiring full FOVs with each strobe and minimizing vibration effects - delivering good accuracy and consistent repeatability. You can measure ANY PCB surface - including flexible circuits - as white light causes minimum diffusion. With its continuous image acquisition, you can be assured of fast, focused and reliable inspection.

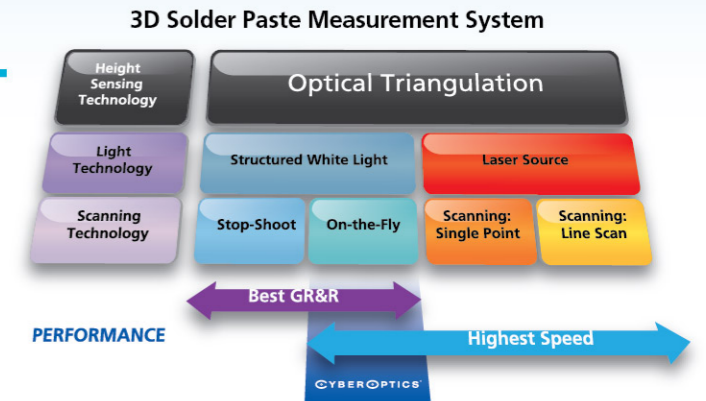

FEEDBACK, FEED FORWARD READY

SE600™ fully supports feedback and feed forward capability with leading Solder Paste Printer and SMT Moulder vendors respectively. With simple configuration settings, SE600™ gives you the power to do more with SPI results - optimize printing process, establish stencil cleaning cycles and fine-tune printer setup. All this means reduced rework costs, increased production throughput and improved yields.

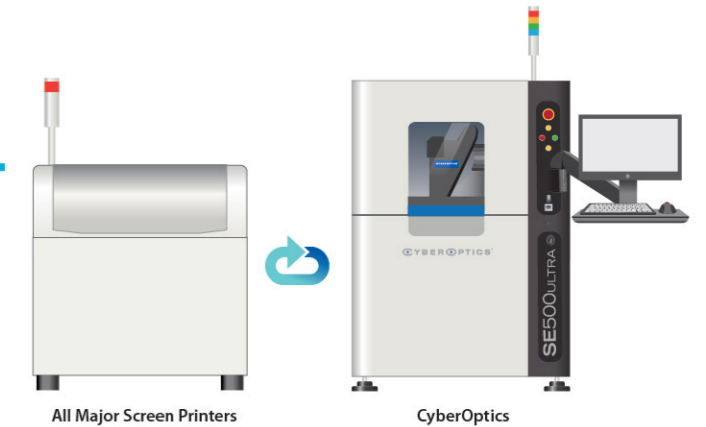

CYBERPRINT OPTIMIZER™ READY



EM Asia Innovation Award for CyberPrint OPTIMIZER™

CyberPrint OPTIMIZER™ automatically optimizes the print process by proactively analyzing accurate trend data – *first-ever in the industry!* Pre-defined templates help you get started quickly while customizable rules support perfect customization for specific product needs. CyberPrint

OPTIMIZER™'s predictive process improvement gets you better yields and reduces downtime.

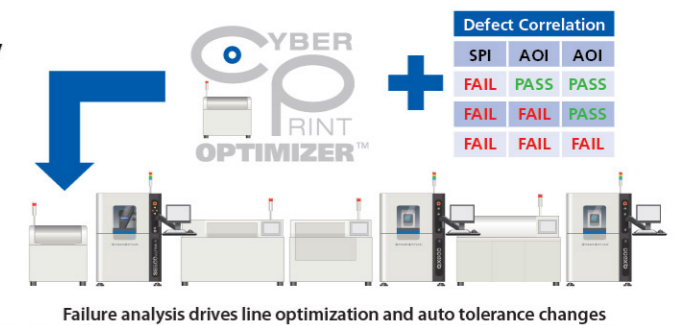

SMART PROCESS CONTROL

CyberOptics™ offers a full range of historical data analysis tools with drill-down capability and auto-reporting feature.